

3305-B-2RSR-TVH

Angular contact ball bearings Double row sealed

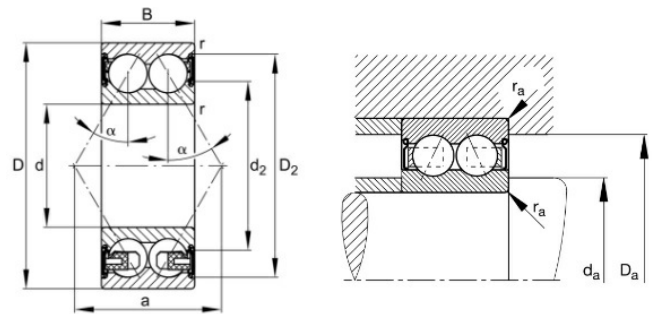

Technical sheet of 3305-B-2RSR-TVH

What are the Benefits of choosing 3305-B-2RSR-TVH bearings?

- **Bidirectional Load Capacity:** A single bearing can simultaneously withstand bidirectional axial and radial loads, eliminating the need for paired installation.
- **High Rigidity and Anti-Overturning:** A large contact angle design effectively resists tilting moments, ensuring shaft system stability.
- **Compact Structure:** Occupies minimal axial space, simplifying housing design and facilitating installation.

Type :	Double row angular contact ball bearings	
Model :	3305-B-2RSR-TVH	
Main demensions :	25 mm × 62 mm × 25.4 mm	Bore Dia × Outside Dia × Width Dia
M kg:	0.349	Mass
HS Code :	8482103000	Bearing customs code
d mm:	25	inner ring diameter
D mm:	62	Outer ring diameter
B(T) mm:	25.4	Overall Width
Cr kN:	31.46	Radial dynamic load rating
C0r kN:	20.988	Radial static load rating
Oil r/min:	9281	Limiting speed

Detailed parameters and installation dimensions:

Part Number	3305-B-2RSR-TVH
Design Type	B = Bearing without filling slot
Series	33...BD-XL-2HRS-TVH
X-Life	XL
Limiting speed (oil) - n_G	9281 min ⁻¹
Bearing Mass - m	0.349 kg 0.769 lb
Reference From	FAG 3305-B-2RSR-TVH
Dimension Inside - d ϕ	25 mm 0.984 inch
Dimension Outside - D Φ	62 mm 2.441 inch
Dimension Width - B	25.4 mm 1.000 inch
Rows NO.	double
Accuracy class	P6
Dimension - r(min.)	1.1 mm 0.043 inch
Seal	2HRS = Contact seal on both sides
Dimension - D ₁	51.47 mm 2.026 inch
Dimension - D ₂	53.72 mm 2.115 inch
Radial static Capacity - C _{0r}	20988 N 4718 lbf
Bore Type	Z = Cylindrical Bore
Heat stabilization	SN = up to 120°
Dimension - d ₁	39.5 mm 1.555 inch
Dimension - d ₂	37.63 mm 1.481 inch
Dimension - a	35.4 mm 1.394 inch
Manufacturer Part Code	3305-BD-2HRS-TVH
Contact angle - α	30 °
Mounting dimensions - d _a (min.)	32 mm 1.260 inch
Mounting dimensions - D _a (max.)	55 mm 2.165 inch
Bearing Type	Angular contact ball bearings Double row sealed
Mounting dimensions - r _a (max.)	1 mm 0.039 inch
Temperature - T(min)	-20°C
Temperature - T(max)	100°C
Ring Material	GCr15SiMn
Cage	TVH = Solid polyamide snap cage, ball-guided
Radial Dynamic Capacity - C _r	31460 N 7072 lbf
Ball Material	GCr15SiMn
RIC	CN
Radial Fatigue Capacity - C _{ur}	1447 N 325 lbf
Equivalent	3305-B-2RSR-TVH,3305-BD-2HRS-TVH
Lubricant	GA14 = Ball bearing grease, low noise

What are the applications of the 3305-B-2RSR-TVH bearing?

- **Gearboxes/Reducers:** Used in industrial gearboxes and planetary reducers. Withstands bidirectional composite loads, provides high rigidity support, and ensures smooth transmission.
- **Pumps/Compressors:** Used in centrifugal pumps, screw pumps, and refrigeration compressors. Precise axial positioning, compact structure, and space-saving installation.
- **Agitators/Worm Gear Drives:** Used in agitators, worm gear reducers, and machine tool indexing heads. Effectively resists tilting moments; a single bearing solves bidirectional axial positioning.

Tradebearing(TBS): <https://en.tradebearings.com/>

Email: admin@tradebearings.com

Whatsapp/Mob.: +86 15906428604